



# Your guide to operation and maintenance



# Claim your M&S voucher and special edition mug

We hope you're delighted with your new installation.

Please get in touch to find out whether your home would be suitable for a photographic session – and we'll do the rest!

We're looking for all types of buildings to photograph, to show off Liniar products at their best.

If we can arrange for a photographer to visit, for no more than an hour, you will receive as our thank you:

- A full set of your high resolution images on a memory stick;
- A Marks and Spencer voucher for £25; AND
- An exclusive limited edition Liniar coffee mug with lid.

Just email us at:

[marketing@liniar.co.uk](mailto:marketing@liniar.co.uk)

with your contact details and a quick photograph.





# Congratulations

on your brand new Liniar installation.

Whether you've purchased Liniar windows, doors, bi-folds, patio doors, French doors, a full conservatory or the Liniar outdoor range of decking and fencing products, this guide will help you to keep your Liniar products looking, and working, their best for many years to come.

We've included performance, accreditation and warranty details, together with a variety of useful tips and information to help you follow the correct operating procedures and carry out simple maintenance.

Please spend some time to familiarise yourself with the contents to ensure you enjoy your Liniar installation and get the best from your investment.

Note: Liniar products are technically engineered and require specialist parts and experience to install. Never attempt any repairs to a Liniar product yourself as this may invalidate your warranty – always contact your installer in the first instance.

It is important you follow the guidance in this manual to ensure warranties are maintained.

In the unlikely event of any difficulties, please contact your installer in the first instance, who will be pleased to help you.

Your Liniar installer's details can be found on the back of this guide.

As Liniar has a policy of continuous improvement in products, methods and materials, changes in specification may be made from time to time without prior notice.



# Quality assured

The Liniar products you have purchased have been subjected to extensive testing during their design and build. The company's UK-based PVCu extrusion facility is accredited with ISO 9001:2000 for quality systems.

## Accredited

In addition, Liniar products have attained the following industry accreditation:

- BS EN 12608:2003 (formerly BS7413) Unplasticized polyvinylchloride (PVCu) profiles for the fabrication of windows and doors.
- PAS 24:2012 – Enhanced security for windows and doors.
- BBA accreditation for white casement and tilt & turn windows.
- Secured by Design status for windows and doors.
- Tested to the requirements of BS7412 – Plastics windows made from unplasticized polyvinylchloride (PVCu) extruded hollow profiles.



BS EN 12608:2003  
KM522037



PAS 24:2012  
KM522039



PAS 24:2012  
KM522040

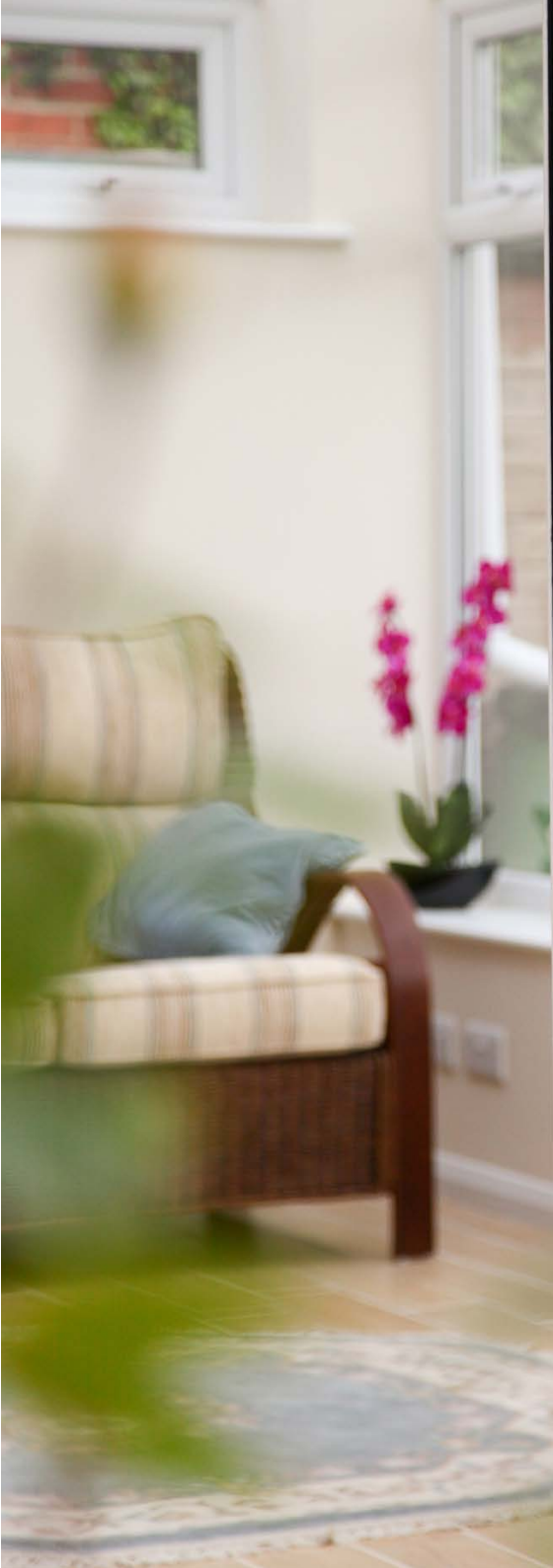



## Contents

Cleaning	6
General maintenance	8
Condensation	10
Security	12
Glazing	13

### Operation and Maintenance

Open out windows	14
Tilt & turn	16
Window restrictors	18
Residential doors	20
French/double doors	22
Patio doors	23
Bi-fold doors	24
The Liniar outdoor range	26
Dos and Don'ts	30
Liniar guarantees	31

# Cleaning

Your Liniar glazed products require a minimal amount of care in order to give you trouble-free operation and remain in optimum condition for many years to come.

The following information will show you the most effective way to clean your Liniar products.

## Standard PVCu frames

- Wash frames with a soap and water solution (dilute washing up liquid is fine) to avoid the build-up of grime and atmospheric deposits.
- For stubborn stains, use a non-abrasive PVCu liquid cleaner. Use sparingly and buff to shine.
- Avoid solvent-based cleaners and take care not to disturb any sealants.

## Coloured foiled PVCu frames

- Only use a soap and water solution to clean woodgrained or foiled windows.
- Never use cleaning fluid or solvent-based cleaners.
- Minor scratches can be repaired using a matching touch-up pen

## Hardware and furniture

- Only clean with a soap and water solution.
- Do not use abrasive cleaners.

## Glazed units

- Remove all hand jewellery prior to cleaning to avoid scratching.
- Remove any heavy external grime with a soap and water solution first.
- Use any proprietary household cleaner, applying with a soft cloth and buffing to a shine.
- Glass fitted with external Georgian bars may be cleaned in exactly the same way, taking care not to disturb.

## Leaded glass

- If leaded strips are bonded to the glazed unit, take extra care as excessive pressure may dislodge the lead from the glass surface.
- Use a soft cloth with warm soapy water, applied with moderate pressure.
- Note that external lead will oxidise. This is a natural phenomenon and cannot be avoided.

## Conservatory or porch roofs

Linlar do not advise the access of a conservatory roof without the use of scaffolding or platforms.

Never lean ladders against PVCu frames, gutters or glass as this may result in damage.

Keep all gutters and outlets clear of leaves and other debris to maintain efficient operation.

### Self cleaning glass

- Do not use abrasive or solvent based cleaners on the external glazing surface as the self-cleaning properties may be affected.
- Use a soft cloth with warm soapy water and buff to a shine.
- A proprietary household cleaner may be used on the inside of the glass.

### Polycarbonate

- Clean in a similar manner to PVCu frames, removing grime and atmospheric deposits to avoid build-up.





# General maintenance

## Lubrication

All locking systems require periodic lubrication, and your Liniar windows and doors are no exception.

- For hardware and opening mechanisms, use light machine oil (for example, 3-in-1) or silicone based spray.

## Drainage

All Liniar glazed products are designed with an in-built drainage system, comprising of slots within the lower thresholds that allow any water ingress to flow on the outside. To ensure an efficient system, these slots must remain unblocked.

Periodically remove dirt, clean drain holes and check the drainage operation by flushing through with water.

## Mastic seal



The mastic seal is the waterproof seal found around your doors and windows.

Please note that some discolouration of the seal is a natural occurrence and cannot be avoided.

Periodically check that the seal is still intact between frame and brickwork.







# Condensation

Water vapour is naturally present in the atmosphere.

In the home, this natural water content is increased by normal day to day living – for example, activity that generates steam such as cooking, bathing, laundering, boiling a kettle and even breathing.

The water vapour remains undetectable while floating in warm air – but upon contact with cold surfaces such as windows, mirrors and tiles, condensation occurs as the vapour turns into water droplets.

Traditional house construction allowed the escape of this water vapour through natural ventilation, including open flues of coal fires, air bricks and ill-fitting

windows and doors – however the drive to conserve energy and reduce heating costs has led to the sealing of homes, resulting in trapped water vapour and increased problems of condensation.

With Liniar's highly energy efficient windows and doors, condensation can even form on the outside face of a double glazed unit, due to the outside surface being much colder than the inside – this is perfectly normal and nothing to worry about.

Certain elevations of property can be more susceptible to condensation e.g. north facing.



## Ventilation

Provide ventilation in your home wherever possible by:

- Opening a window (please bear security in mind when leaving open an easily accessible window)
- Fitting a ventilation or extraction unit in the kitchen and bathroom
- Fitting wall vents to provide air flow.

## Heating

Maintain heat in the house during cold weather and marginally increase the temperature in areas where condensation is a particular problem.

An electric dehumidifier can help in problem areas by extracting excess vapour from the air.

## Circulation

Water vapour will easily drift from its originating point due to the convection currents in your home. To avoid this:

- Keep internal doors to kitchen and bathroom areas closed and draught-sealed where possible.
- Ensure bedrooms are ventilated at night to provide air movement. If doors must be closed, install a ventilation grille in or above the door.
- To ensure air flow in the vicinity of windows, curtains should be a minimum of 150mm (6") away from the window, with suitable gaps at the top and bottom.



# Security

Your Linear windows, doors and roof have been specifically designed to include a number of security features to protect your home and family against intrusion.

## **Remember: prevention is better than cure.**

We recommend the following sensible security precautions should also be taken:

- Never leave a window or door open when your home is unattended.
- Lock all windows whenever they are in the closed position and remove all keys.
- To provide adequate means of escape in an emergency, locate keys adjacent to the window but out of external view.
- When leaving the house unattended at night, ensure door handles are fully lifted and that the keys are turned, in order to throw and lock all deadbolts and shootbolts for full security.





# Glazing information

## Glass imperfections

All double and triple glazed units are susceptible to a degree of surface damage during the manufacturing process. Certain imperfections in the glass cannot be avoided, even in the most carefully controlled production environment.

Such blemishes and imperfections are therefore beyond our control, but are considered acceptable by even the most rigorous industry standards – we would like to draw your attention to the following extract from an industry-accepted standard in relation to glass:

1. Transparent glass used in the manufacture of double glazed units is identical to that used in traditional single glazing and will therefore have a similar level of quality.
2. Both panes of the double glazed unit shall be viewed from the room side, standing at a distance of two metres (6'6") in natural daylight and not in direct sunlight. The area to be viewed is the normal vision area, with the exception of a 50mm (2") wide band around the perimeter of the unit.
3. Flat transparent glass shall be deemed acceptable if the

following phenomenon are neither obtrusive nor bunched:

- Totally enclosed seeds
  - Bubbles or blisters
  - Hairlines or blobs
  - Fine scratched, not more than 25mm (1") long
  - Minute embedded particles.
4. Obtrusiveness of blemishes shall be judged by looking through the glass and not at it, under normal lighting conditions as described in point 2.

## Other glazing information

Your installer has used only the highest quality float glass available, whether laminated, toughened or annealed, which conforms to the requirements of BS 6262.

Double and triple glazed units produced to BS 7513 conform to the highest manufacturing standards and the most uncompromising quality control and inspection routines.

Patterned glass originates in very large sheets and due to spacing repetition, centralisation of any design in a specific window cannot be guaranteed.

# Operation and maintenance

Pages 14-24 will show you how to care for your Liniar glazed products.

## Open out windows

Liniar's windows may be opened outwards and are fitted with friction hinges, with the type being either egress, easy clean or restricted, that hold them in any desired position when open.

The locking mechanism, which can be either espag or shootbolt locking, fitted to the opening edge of the window, engages with slotted 'keeps' fitted to the outer frame. The secondary slot within the keep enables the window to provide a 'night vent' position,

with the window only slightly open whilst providing ventilation.

**NB: Accessible windows should not be kept in the 'night vent' position when the house is unoccupied.**

To open, turn the key if fitted, then push the button in the centre and whilst pressed, turn the handle through 90° to unlock the handle. To close, simply turn the handle back the other way until it engages with the lock. Once closed, turn the key to lock the window and remove it to keep somewhere safe nearby.



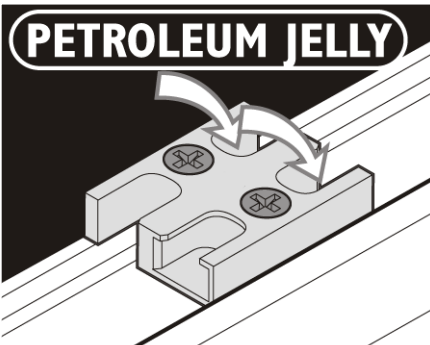
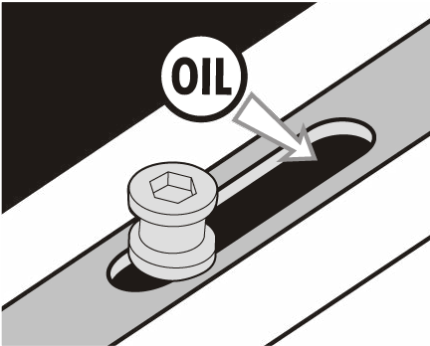
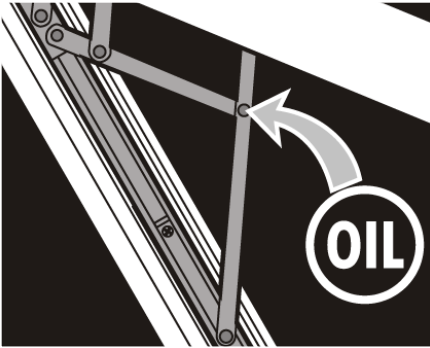

# Maintenance

## Friction hinges

To attain optimum performance the scissor mechanism of the friction hinges will require periodic lubrication. The pivots, sliding shoe and tracts should be kept free of dirt and debris.

## Lubrication - as required

Oil all pivot points (one drop per pivot is sufficient) and wipe away excess.

## Espagnolette - locking mechanism

Lubricate - as required.

Keep the sliding mechanism free of dirt and lubricate each slot with light machine oil.

## Keeps

Lubricate the slots of the keeps with petroleum jelly as required.

## Handles - (espagnolette locking)

Clean and lightly oil moving parts.

## Tilt & Turn windows

Liniar's versatile tilt and turn windows are fitted with 'tilt before turn' (TBT) mechanisms for safety reasons – ensuring the window cannot be easily opened by children. This style of window is capable of two modes of operation:

- Tilt mode for ventilation
- Turn mode for cleaning and emergency exits

As the name suggests, the tilt mode must be performed prior to turning the window – however these windows may also be supplied in 'turn before tilt' mode where the sequence is reversed.

If you are in any doubt as to the sequence of operation for your windows, please contact your installer.

**NB: The window must always be fully closed before changing the handle's position.**

To operate the window, the handle should be in one of three positions: Closed, Tilt or Turn

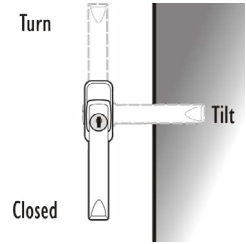

If fitted, turn the key to unlock the window.

To select Tilt mode, rotate the handle through 90° from downwards to horizontal, and pull the window inwards towards you. The bottom of the window will remain hinged to the frame, while the top tilts inwards to allow ventilation.

To select Turn mode, close the window and rotate the handle through another 90° until it points upwards, then pull the window inwards. The side will now remain hinged to the frame while the window will open inwards to any desired position.





## (SWITCH BARRIER)

**DO NOT TOUCH**

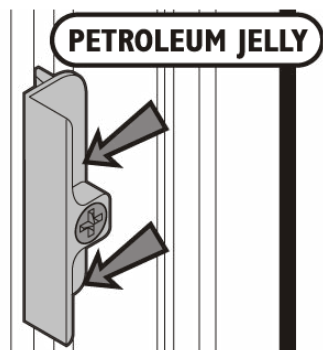
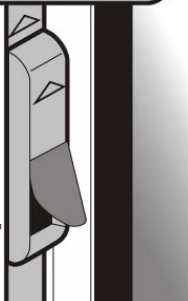

# Maintenance

The switch barrier projecting from the locking mechanism, adjacent to the handle, is a safety device. It ensures that only one mode ('tilt' or 'turn') can be selected at any one time, by securing the handle into the selected mode, while the window is open.

Avoid pressing the switch barrier as this action releases the handle and could allow it to be inadvertently rotated to the alternative mode, resulting in the window disengaging from its hinge points

Always firmly close the window before changing the handle position.

## TBT locking mechanism

Keep sliding mechanism free of dirt and lubricate each slot with light machine oil as required.

## Keeps

Lubricate the faces of the keeps with petroleum jelly as required.

## Handles

Clean and lightly oil moving parts.

## Window restrictors

If fitted, the restrictor limits the opening of the window to control ventilation.

The restrictor may be disengaged to allow the window to be fully opened.

There are two main types of restrictor, the standard casement restrictor and the security restrictor.

Friction stays may also be restricted.

## Standard casement restrictor opening instructions

### To open - restricted

Operate handle and open window. The restrictor arm will limit opening.

### To open - fully

Once opened to the restricted position, close the window slightly and manually release the restrictor by lining up the slot opening with the striker post, whilst holding the latch, open fully.

### To close

Close the window in the normal manner. The restrictor will automatically re-engage.



## Security restrictor operating instructions

A special key is supplied to provide adjustment for the swinging arm and to enable the unit to be locked.

### To open - restricted

Select required mode and open the window. The restrictor arm will limit opening.

### To open - fully

Close window. While holding down control button, re-open the window. Release button as soon as window has cleared the frame.

### To lock restrictor

Insert special key at the back of the unit and rotate clockwise half a turn.

Note: to provide adequate means of escape in the event of an emergency, we recommend that the keys to all windows are located adjacent to the window, but out of external view.

### To adjust swinging arm

Insert the key into the socket at the side of the unit and rotate clockwise to tighten swinging arm or anti-clockwise to loosen.

Note: in the unlikely event that adjustment is needed, only a small movement (1/4 turn) will be required.

### To close

Close the window in the normal manner. The restrictor will automatically re-engage.

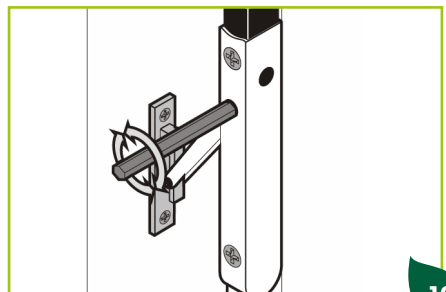
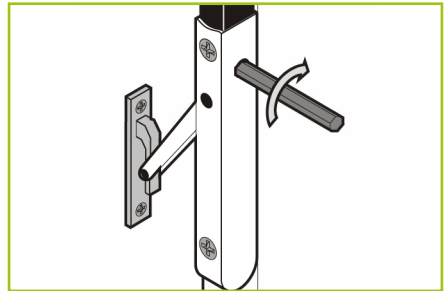
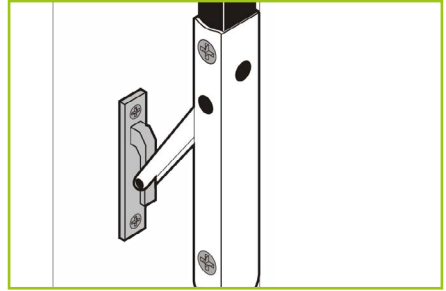

## Liniar Residential Doors

Liniar PVCu doors are available in a variety of styles and operations.

Doors may be fitted with lever/ pad handles that limit outside opening by use of a key, or twin hookbolts and a single deadbolt combination with latch and lock.

In addition, up to 4 rollers may be present.

All locking points engage in keeps fitted to the frame jamb.

The top and bottom deadbolts, hookbolts and rollers (if fitted) are engaged by lifting the handle.

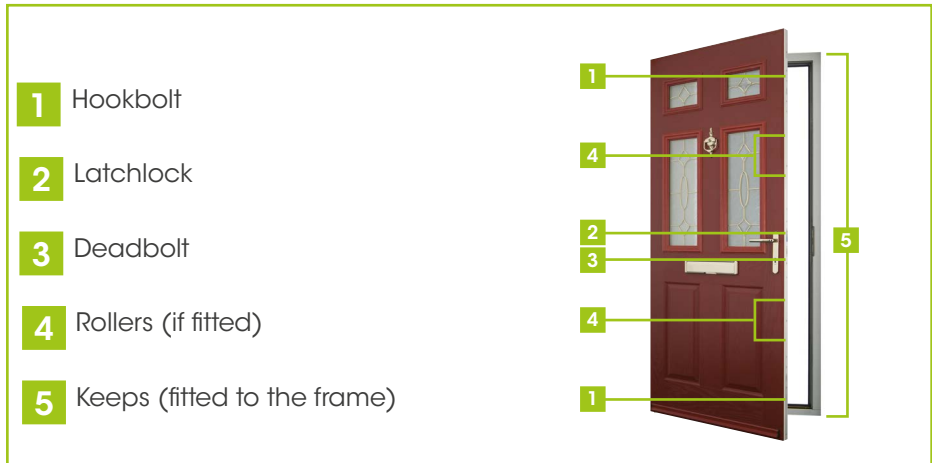



## To lock

1. Close the door - latch engaged.
2. Lift the handle or pad to engage the top and bottom deadbolts/ hookbolts/rollers.
3. Insert key and turn to engage centre deadbolt and fully lock.

If the key will not turn, lift the handle or pad to maximum.

## To unlock

1. Insert the key and turn to unlock.
2. Press handle or pad down to disengage top and bottom deadbolts/hookbolts/rollers.
3. With level handle, door will open.
4. With pad handle, continue to turn key to open.

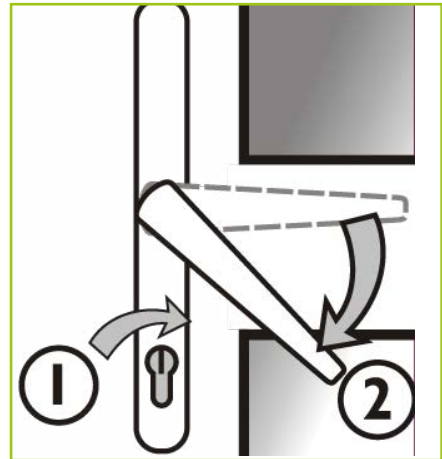
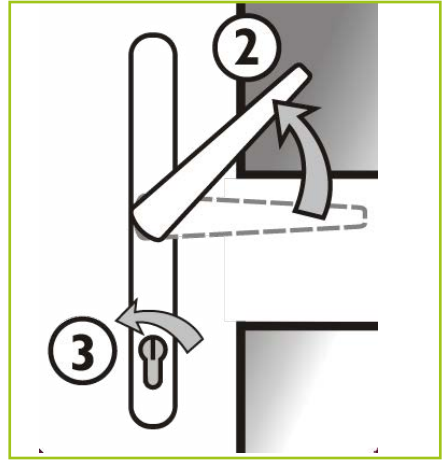

# Maintenance

## Locking mechanism

With door open, lubricate the deadbolts, hookbolts, rollers and latchlock with light machine oil if required. DO NOT add additional lubricant to the lock cylinder as this is packed with special grease.

Clean and lightly oil external moving parts.

## Hinges

Clean with a soap and water solution. No lubrication is required.

## French or double doors

Dependent upon the locking mechanism fitted to your door, there are two slave door locking options:

- Full slave locking (a handle operated shootbolt that operates in the same way as the master door)
- Fingerbolts (hand operated fingerbolts fitted to the top and bottom of the slave door). There is no handle present on this type of locking option.

Always open the master door first to avoid spraining the lock. Your installer should have shown you which door is the master.

To lock the door after use, turn the handle upwards to engage the multi-point locks and then turn the key.



## Maintenance

- Ensure frames are free of dirt by cleaning with soap and water.
- Check drainage holes and remove any blockages.
- Lubricate pivot point with light machine oil.
- Minor foil scratches can be repaired using a matching touch-up pen.
- Check for obstructions, signs of wear and ensure fixing screws are secure.



## Patio doors

Liniar patio doors are fitted with its patented integral high security ModLok™ locking mechanism, featuring a multi-point locking system and shoot-bolts with integral reinforcement, together with bespoke Liniar leaf-embossed handle.

To open, move the lever upwards, take hold of the handle and slide the door open. To close and lock, ensure the door is in contact with the frame and move the lever into the downward position.



## Maintenance

- Ensure frames and tracks are free of dirt by cleaning with soap and water.
- Check drainage holes and remove any blockages.
- Minor foil scratches can be repaired using a matching touch-up pen.
- Check for obstructions, signs of wear and ensure fixing screws are secure. Keep brush pile free from dirt.

## Bi-fold doors

Liniar's range of bi-folding doors is available in configurations from 2 to 7 panes, opening in or out. Your bi-fold will either be a Standard or ModLok™ bi-fold – the difference can be seen in the end panel of the door, as shown to the right.

It is important that you open and close your bi-fold in the correct sequence. Below shows how to open and close a 3-2-1 bi-fold correctly.



To see all opening/closing sequences visit our website at:

[www.liniar.co.uk/bifoldopeningclosing](http://www.liniar.co.uk/bifoldopeningclosing)

### Opening sequence

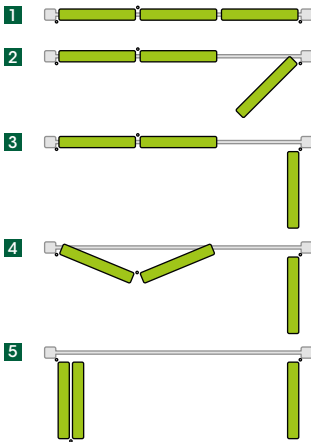

### Closing sequence

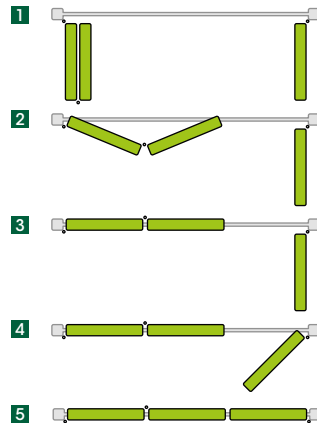

## Maintenance

- Rolling mechanisms carrying the door panels are fitted with sealed stainless steel bearings and require no lubrication.
- Ensure top and bottom tracks are kept free from debris, which may impair the function.
- Door locking mechanisms should be cleaned and any moving parts lubricated with a light machine oil at least once a year and more frequently where appropriate.







# Caring for the **Liniar** outdoor range

Liniar's product range extends not only to your home, but your garden and holiday home too. With a choice of decking and handrails, fence posts and gravel boards, picket fencing and piling and retention, you can be sure of lower maintenance when compared with timber.

## **Liniar PVCu decking**

Your Liniar decking should be installed on a galvanised steel sub-frame in accordance with the instructions in our installation guide.

No maintenance is required for the Liniar decking system, but as with any outdoor surface, a regular clean is recommended to keep it looking at its best.

Use a soft brush with warm soapy water to clean dirt from the deckboards – and any stubborn marks may be removed with the use of a jet-washing machine.

## **Liniar PVCu fencing**

All Liniar fence posts, gravel boards and picket fencing systems require very little maintenance to make sure they enhance your garden for years to come.

If necessary, wash with warm soapy water and a soft cloth, and buff to a shine with a window chamois or leather.





## Liniar piling and retention

If you've installed Liniar log pile in your garden, either for pond erosion protection, soil retention or simply for decorative purposes, you won't need to sand, paint or varnish it to maintain its appearance.

The fascia is made from a timber and PVCu composite, so it won't peel off, and the product will age naturally - with flora and fauna such as trailing plants attaching themselves just as they would to timber.

A quick spray with the hosepipe whilst watering your plants should be all that's necessary to keep it clean.

As with all Liniar PVCu products, do not use any hard abrasives or harsh chemicals.

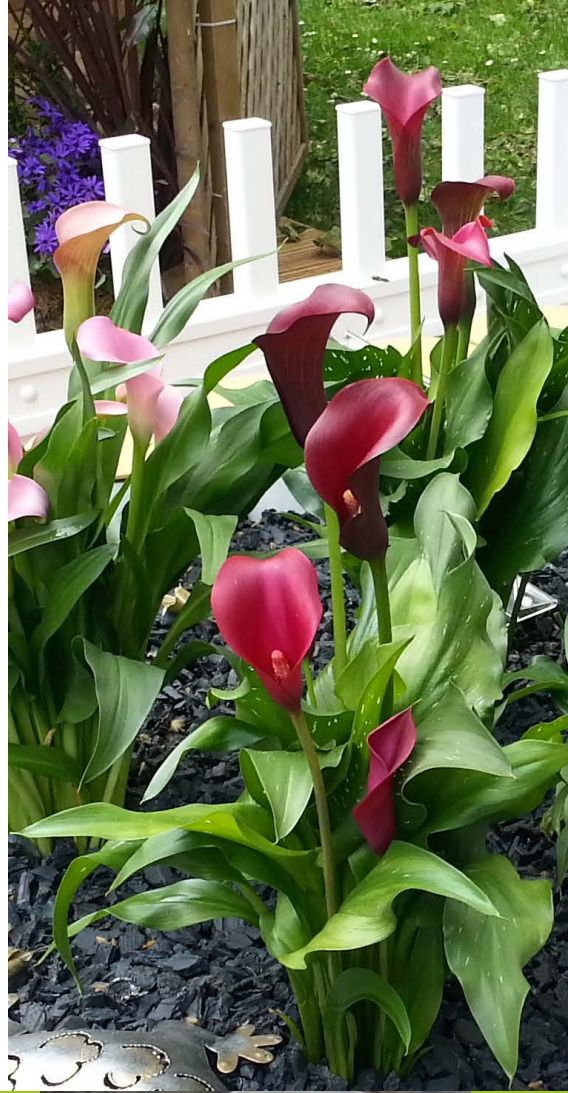





# Dos & Don'ts

The following section indicates simple best practice 'dos and don'ts' to ensure continual optimum performance of your Liniar products.

## Do

- ✓ Clean the glass regularly with a good quality liquid spray glass cleaner
- ✓ Frequently wash down the PVCu profiles with warm soapy water and wipe dry
- ✓ Only use cleaning materials which do not impair anti-corrosion properties of the surface coatings
- ✓ Use cream cleaner for isolated stubborn stains on white PVCu only. Apply with a damp cloth using minimal pressure
- ✓ Ensure drainage slots are unblocked and free from dirt and debris
- ✓ Keep all tracks clear of dust and debris in order to reduce wear and tear on sliding parts
- ✓ Check all fire escapes' hardware regularly for wear and tear and a consistent fit
- ✓ Ensure conservatory gutters and their outlets are kept clear of leaves and debris to ensure unobstructed flow
- ✓ All moving mechanical parts are lubricated - hinges, locks and keep plates will benefit from a small application of light oil at least once a year
- ✓ Replace damaged or worn parts with original Liniar parts.

## Don't

- ✗ Use any type of bleach, solvent (e.g. white spirit, methylated spirits, nail varnish remover) or adhesives
- ✗ Use abrasives or brass cleaner on furniture: handles, door knockers, letter plates
- ✗ Use glass cleaner on the PVCu profile
- ✗ Use abrasive paste or cream cleaners on any PVCu profile
- ✗ Use high pressure or steam cleaners
- ✗ Use any abrasive papers, such as sandpaper
- ✗ Use excessive loads on the windows and doors
- ✗ Lean ladders against conservatory guttering
- ✗ Paint the PVCu profile
- ✗ Use any unspecified tools
- ✗ Use abrasive or solvent-based cleaners on self-cleaning glass.



Guarantee  **Liniar**

# 10 Year guarantee

profiles are manufactured using tried and tested formulations from approved suppliers and will not warp, split or discolour for 10 years from date of installation.

This guarantee is issued in association with our raw material suppliers and based on proven technology for UV stabilised products.

Further details and full conditions can be supplied on request.

All products to be installed to Liniar recommendations.



[www.liniar.co](http://www.liniar.co)

# LINIAR 10 YEAR COMPONENT PRODUCT GUARANTEE

Liniar PVCu products are manufactured using tried and tested formulations from approved suppliers. We guarantee they will not warp or split for 10 years from the date of installation providing they are installed by a Liniar approved installer and maintained with our guidelines.

This guarantee is issued in association with our raw material suppliers and is based on proven technology for PVCu products. Further details can be supplied on request.

All products to be installed to Liniar recommendations.

## Guaranteed

Liniar profiles are manufactured using tried and tested formulations from approved suppliers and will not warp, split or discolour for 10 years\* from date of installation.

The Liniar guarantee is issued in association with our raw material suppliers and based on proven technology for UV stabilised products.

Further details, weathering data and full conditions can be supplied on request.

All products are to be installed to Liniar recommendations.

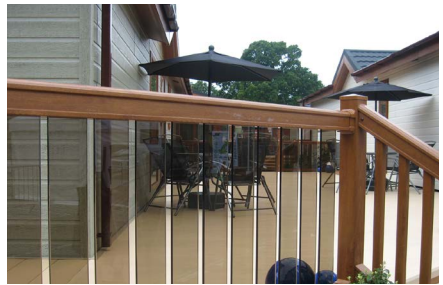

\* Liniar bi-folding doors consist of a wide variety of components that cannot be covered under one guarantee - see separate product guarantee for more information.

# 7 great reasons to choose Liniar

**Innovative** - continual investment in research, development and testing delivers the most advanced products on the market.

**Energy efficient** - designed from scratch to achieve the pinnacle of thermal performance and retain more heat in your property

**Safe and secure** - engineered with built-in security features and approved by independent testing facilities

**British made** - Liniar PVCu is extruded in our state-of-the-art factory in the heart of Derbyshire

**Lead free** - all Liniar products use materials that are 100% lead free

**Quality assured** - backed with ISO 9001 accreditation for your peace of mind

**Guaranteed** - all Liniar products are guaranteed - see individual product guarantees for details



Your Liniar stockist is:

**Liniar**  
Flamstead House  
Denby Hall Business Park  
Denby  
Derbyshire DE5 8JX

Tel: +44 (0)1332 883900  
Fax: +44 (0)1332 883901  
Email: [sales@liniar.co.uk](mailto:sales@liniar.co.uk)

[www.liniar.co.uk](http://www.liniar.co.uk)

